

SOFT START OF AN INDUCTION MOTOR **USING DSPACE**

*A Project report submitted in partial fulfilment
of the requirements for the degree of B. Tech in Electrical Engineering*

By

Bikram Chowdhury (EE2014/063)

Arghyadeep Patra (EE2014/058)

Archis Rudra (EE2014/062)

Mainak Dutta (EE2015/L01)

Under the supervision of

Dr. Shilpi Bhattacharya
Associate Professor
Dept. of the Electrical Engineering



Department of Electrical Engineering

RCC INSTITUTE OF INFORMATION TECHNOLOGY

CANAL SOUTH ROAD, BELIAGHATA, KOLKATA – 700015, WEST BENGAL

Maulana Abul Kalam Azad University of Technology (MAKAUT)

©2018

ACKNOWLEDGEMENT

It is my great fortune that we have got opportunity to carry out this project work under the supervision of **Dr. Shilpi Bhattacharya** in the Department of Electrical Engineering, RCC Institute of Information Technology (RCCIIT), Canal South Road, Beliaghata, Kolkata-700015, affiliated to Maulana Abul Kalam Azad University of Technology (MAKAUT), West Bengal, India. we express my sincere thanks and deepest sense of gratitude to my guide for his constant support, unparalleled guidance and limitless encouragement.

We wish to convey my gratitude to Prof. (Dr.) Alok Kole, HOD, Department of Electrical Engineering, RCCIIT and to the authority of RCCIIT for providing all kinds of infrastructural facility towards the research work.

We would also like to convey my gratitude to all the faculty members and staffs of the Department of Electrical Engineering, RCCIIT for their whole hearted cooperation to make this work turn into reality.

We would also like to thank FINANCIAL DEPARTMENT, RCCIIT for financial support to perform this project work.

Signature of Student

Place:

Date:

CERTIFICATE

To whom it may concern

This is to certify that the project work entitled **Soft Start of an Induction Motor** is the bona fide work carried out by,

Archis Rudra (EE2014/062),

Arghyadeep Patra (EE2014/058),

Bikram Chowdhury (EE2014/063),

Mainak Dutta (EE2015/L01),

students of B. Tech in the Dept. of Electrical Engineering, RCC institute of Information Technology (RCCIIT), Canal South Road, Beliaghata, Kolkata-700015, affiliated to Maulana Abul Kalam Azad University of Technology (MAKAUT), West Bengal, India, during the academic year 2017-18, in partial fulfillment of the requirements for the degree of Bachelor Of Technology in Electrical Engineering and that this project has not submitted previously for the award of any other degree, diploma and fellowship.

Signature of the Guide
Dr. Shilpi Bhattacharya
Designation : Associate Professor

Signature of the HOD
Alok Koley
Professor & HOD

Signature of the External Examiner
Name:_____

Designation:_____

TABLE OF CONTENTS

<i>Content</i>		<i>Page no.</i>
List of Figures		4
Abstract		6
1.	Introduction	7
	1.1 Background	7
	1.2 Problem Statement	8
	1.3 Problem Objective	8
2.	Theory	9
	2.1 Starting	9
	2.2 STAR VOLTAGE CONTROL METHOD of Induction motor	10
	2.3 Soft starter	12
	2.4 Induction Motor	12
	2.5 dSPACE	13
	2.6 MATLAB and Simulink	16
3.	Software Implementation	17
	3.1 Zcd and delayed output waveform	18
	3.2 Main Simulation diagram	19
	3.3 dSpace Control Desk	20
4.	Hardware Implementation	21
	4.1 Block Diagram	21
	4.2 Circuit Diagram	21
	4.3 Circuit Description	22
	4.4 Hardware Model	22
	4.5 Full setup of Final Testing	23
	4.5 List of Hardware Component	24
	4.6 Main Hardware Component Used	25
	4.7 Observation and results	26
5.	Conclusion	28
6.	Future aspect of the project	28
7.	Appendix A	29
8.	References	46

List of Figures

Fig.1: Speed-Torque characteristics with variable stator voltage

Fig.2: Stator voltage control by semiconductor voltage controller

Fig.3: Cutaway view through stator of the Induction Motor

Fig. 4: CONTROLLER BOARD OF DS1202

Fig.5: Dspace Micro Lab Box Toolkit

Fig.6: Waveform of ZCD and delayed output

Fig.7: ZCD and delayed output waveform using MATLAB

Fig.8: Simulink Circuit Diagram (ZCD along with triggering circuit)

Fig.9: 120° firing angle

Fig.10: 90° firing angle

Fig.11: 45° firing angle

Fig.12: 0° firing angle

Fig.13: dSpace Control Desk

Fig.14: Block Diagram of Soft starter of an Induction Motor

Fig.15: Circuit Diagram of Soft starter of an Induction Motor

Fig.16 : LIST OF HARDWARE COMPONENT

Fig.17: Full hardware circuit board along with 6v transformer

Fig.18: Final Testing

Fig.19: Real time Simulation

Fig. 20: Pin Description of MOC3021

Fig.21 Pin Description of TRIAC BT-136

Fig.22 Pin Description of BC-547

Fig. 23: Working of Transformer

ABSTRACT

The project is designed to provide a soft and smooth start to the induction motor. An induction motor during the initial starting condition draws up much higher current than its capacity and the motor instantly reaches the full speed. This results in a mechanical jerk and high electrical stress on the windings of the motor. Sometimes the windings may get burnt. The induction motor should start smoothly and gradually catch up the speed for a safer operation. This project is designed to give a soft start to the induction motor based on the TRIAC firing triggered by heavily delayed firing angle during starting and then gradually reducing the delay till it reaches zero voltage triggering. This results in low voltage during start and then gradually to full voltage. Thus the motor starts slowly and then slowly picks up to full speed. The control circuit is developed in MATLAB Simulink and Dspace is used as the control platform. This project consists of one TRIAC in the power circuit, one TRANSISTOR in the driving circuit, Opto-coupler for bridging the circuit, and the output of which is connected to a lamp representing the coil of the induction motor.

When the supply is given to the circuit resulting in delayed firing pulses during start and then gradually reducing the delay till the motor runs at full speed. The Output is fed through opto-coupler to trigger the TRIAC.

1. INTRODUCTION :

1.1 BACKGROUND :

Necessity for Motor Protection :

It could be assumed that properly planned, dimensioned, installed, operated and maintained drives should not break down. However, in real life, these conditions are hardly ever ideal. The frequency of different motor damage differs since it depends on different specific operating conditions.

The induction motor is the most widely used motor in the industry due to its simple and rugged construction. It requires least maintenance as compared to other electrical motors. Therefore, induction motor protection plays an important role in its long life service.

Researchers have done costly and limited protection for stator winding protections, broken rotor bars protection, thermal protection etc. Mainly the induction motor needs protection from variation of the input supply for small motors which is in common use, not only in big industry but also in small scale industries. The small scale industries are not able to provide costly protection to the drives in use as it will increase their capital cost. Therefore a cheap and compact design has been done for protection of induction motors against unbalanced voltages, under voltages, short circuits etc.

Most breakdowns are caused by an overload, insulation faults leading to earth faults, turn-to turn or winding short circuits are caused by excess voltage or contamination by dampness, oil, grease, dust and chemicals.

The approximate percentages by these individual faults are:

Overload	30%
Insulation damage	20%
Phase Failure	14%
Bearing	13%
Ageing	10%
Rotor damage	5%
Others	8%

1.2 PROBLEM STATEMENT

To guarantee fault-free operation of an electrical drive the following points must be observed:

1. **Correct design:** a suitable motor has to be selected for each application.
2. **Professional operation:** professional installation and regular maintenance are preconditions for fault-free operation
3. **Good motor protection:** this has to cover all possible problem areas.
 -) It must not be tripped before the motor is put at risk|
 -) If the motor is put at risk, the protection device has to operate before any damage occurs.|
 -) If damage cannot be prevented, the protection device has to operate quickly in order to restrict the extent of the damage as much as possible.|

|

1.3 PROBLEM OBJECTIVE

The objective of this project is to;

1. Design a soft starter of an induction motor by using DSpace.
2. Reduced voltage starting through delayed triggering angle control of TRIAC.
3. Bypass the TRIAC causing direct voltage supply to the motor once the motor reaches desired speed.

2. THEORY :

2.1 STARTING:

Starting of an electrical drive involves a change in its state from rest to a steady state speed of rotation. The process of starting is the most important phenomenon in the entire operation of the drive. Control of the starting process essentially consists of controlling the acceleration of the driving motor and the latter is basically a problem of modifying the speed torque characteristics of the motor in such a way as to obtain the desired starting performance.

Effect of Starting on Power Supply

While studying starting of electric drive systems, it is necessary to consider three factors:

1. Effect of starting upon the power supply.
2. Effect of starting upon the driving motor itself.

The supply network to which the motor is connected may affect the selection of the starting device from the following viewpoint. The excessive voltage drop due to the peak starting current may interfere with the supply in such a way that it cannot be tolerated by other equipment or other consumers connected to the same power supply network.

Since starting is associated with excessive currents, the effect of starting upon the motor itself must be carefully considered. The starting currents will add to the motor heating by an amount that depends upon their rms values and upon the frequency of starting. In a dc motor the limitation may be good commutation rather than heating, as dc machines have a certain maximum limit for the current dictated by the commutation process.

Methods of Starting Electric Motors

The different methods of starting of the various types of electric motors. They are as follows-

1. ***Full voltage starting:*** This involves the application of full line voltage to the motor terminals. This is also called 'direct-on-line starting'.
2. ***Reduced voltage starting:*** In order to avoid heavy starting current and the consequent voltage dip in the supply lines majority of motors are started by applying a reduced voltage to their terminals and subsequently increasing it to its normal value.

The starting of a dc motor is, often, accomplished by the addition of suitable external resistance in the armature circuit and the starting controller is arranged so that this resistance is short-circuited in steps as the motor comes up to speed.

Reduced voltage starting of induction motors is achieved by

- Stator resistance starting
 - Stator reactor starting
 - Star-delta starting
 - Autotransformer starting
3. **Increased torque starting:** With a wound rotor induction motor, resistance can be added in the rotor circuit so as to decrease the starting current while increasing the starting torque, even, up to the value of maximum torque that can be developed by the motor.
 4. **Starting by means of smooth variation of voltage or frequency:** With ac motor-dc generator sets, dc motors can be started by smooth variation of applied voltage and with variable frequency sources both induction and synchronous motors can be started by smooth variation of supply frequency, simultaneously varying proportionally the applied voltage to the motors.

Why the starting current is high in the induction motor?

In an induction motor it takes starting current around 7 times the full load current. The reason is during starting when we applied a voltage to stator it produce a rotating magnetic field which is rotating with its synchronous speed. The rotor speed is zero and slip is 100% so a large amount of magnetic field cuts the rotor surface and produce heavy current to flow from its and when the rotor catch its speed the amount of field cutting the rotor reduce and slip is also low and current become normal.

2.2 STATOR VOLTAGE CONTROL METHOD

A very simple and economical method of speed control is to vary the stator voltage at constant supply frequency. The three-phase stator voltage at line frequency can be controlled by controlling the switches in the inverter. The developed torque is proportional to the square of the stator supply voltage and a reduction in stator voltage will produce a reduction in speed. Therefore, continuous speed control may be obtained by adjustment of the stator voltage without any alteration in the stator frequency.

$$T_e = 3 \left(\frac{p}{2} \right) \frac{R_r}{s \omega_e} \frac{V_s^2}{\left(R_s + \frac{R_r}{s} \right)^2 + \omega_e^2 (L_l + L_l)^2}$$

The Torque speed curves with variable stator voltage control are shown in Fig.

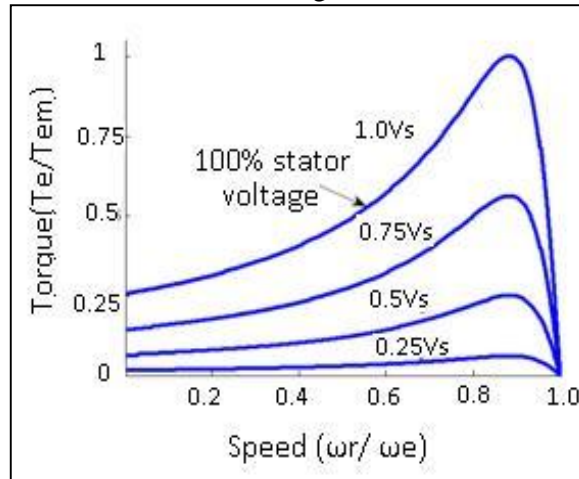

Fig.1: Speed-Torque characteristics with variable stator voltage

The salient features of stator voltage control method are:

- ❖ For low-slip motor, the speed range is very low.
- ❖ Not suitable for constant-torque load.
- ❖ Poor power factor.

Control by ac Voltage Controllers

Domestic fan motors, which are always single-phase, are controlled by a single-phase triac voltage controller.

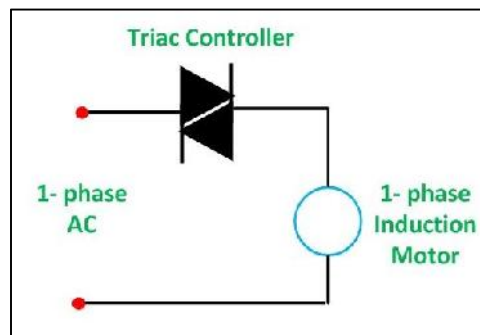

Fig.2: Stator voltage control by semiconductor voltage controller

Speed control is obtained by varying firing angle of the triac. These controllers, commonly known as solid state fan regulators, are now preferred over conventional variable resistance regulators because of higher efficiency.

Since voltage controllers, allow a stepless control of voltage from its zero value, they are also used for soft start of motors.

2.3 Soft Starter:

Soft starters provide all the same functionality as a starter but they allow us to protect the motor from high spikes and voltage that may cause damage to our motor. They do this by preventing that large inrush current to our motor by limiting the voltage and current upon startup. It allows us to slowly ramp up the speed of the motor which causes less wear and tear. It is used only upon startup however depending upon the model we can see them used in the shutdown process of a motor.

Once we actually get up to the full load ampere or full speed of our motor it operates the exact same way as a normal starter.

Advantage:

1. It allows the motor to ramp up slowly to reduce the inrush current to our motor because of this it saves an operating cost.
2. It allows us to increase the longevity of our motor because we are not putting so much torque and wear and tear on that motor upon startup.

Disadvantage:

1. It is more expensive than a starter.
2. It does not give full motor speed control.

2.4 Induction Motor :

An induction motor always runs at speed less than synchronous speed. Because the rotating magnetic field produced in the stator will create flux in the rotor and hence will make the rotor to rotate.



Fig.3: Cutaway view through stator of the Induction Motor

Working Principle of Induction Motor :

When we give the supply to the stator winding, a magnetic flux is produced in the stator due to the flow of current in the coil. The rotor winding is arranged in such a way that each coil becomes short-circuited in the rotor itself.

The flux from the stator cuts the short-circuited coil in the rotor. As the rotor coils are short-circuited, according to Faraday's law of electromagnetic induction, current will start

flowing through the coil of the rotor. When the current through the rotor coils flows, another flux gets generated in the rotor. Now there are two fluxes, one is stator flux, and another is rotor flux. The rotor flux will be lagging with respect to the stator flux. Because of that, the rotor will feel a torque which will make the rotor to rotate in the direction of rotating magnetic field.

2.2 dSPACE :

- 1.** With decades of experience, dSPACE knows about the special requirements of electric drives and hardware-in-the-loop (HIL) simulation. The dSPACE products work together seamlessly to provide a convenient development and test environment. They benefit from hardware such as powerful real-time processors, comprehensive I/O interfaces and so on. dSPACE also offers dedicated function libraries for data processing and for controller or plant models. Sophisticated software supports the transition from the first function model in Simulink to comprehensive real-time tests. dSPACE hardware and software together provide a seamless tool chain whose individual parts are finely tuned to each other.
- 2.** dSPACE supports customers worldwide from the first controller development to the last approval tests. Throughout the development process, dSPACE Engineering Services provide assistance for even the most challenging projects. All this to provide the greatest flexibility at the highest convenience.

CONTROLLER BOARD OF DS1202 :

Fig. 4 shows the entire dSPACE DS1202 controller board internal structure. dSPACE controller board forms the main part of the system as it serves as the connecting link between MATLAB/Simulink inverter model to the real inverter hardware. Some exclusive interfaces are inbuilt in dSPACE DS1202. The special blocks are only available in Matlab Simulink with DS1202 controller platform such as DS1202ADC, DS1202DAC and DS1202BIT_OUT_CX. MATLAB/Simulink Real-Time-Workshop (RTW) function, can be used convert the interface blocks to the C-code automatically [8]. Finally, this code is compiled by a compiler and linked to the real-time dSPACE DS1202 processor board. In addition to this DS1202 also comes with a graphical user interface (GUI) called Control Desk used for observe the performance of the inverter

on an online basis [8]. Various control strategies have been implemented on dSPACE DS1202 control platform such as deadbeat controller, voltage controlled SPWM etc. Here a current controlled pulse-width modulation is implemented in synchronous reference frame. Digital proportional integral (PI) controller is also another method to obtain better quality waveforms from an inverter. A properly designed PI controller using analog components is quite a tedious task especially in ac applications but using DS1202 controller board helps the designer to make the PI controller in Simulink and link it to the real world.

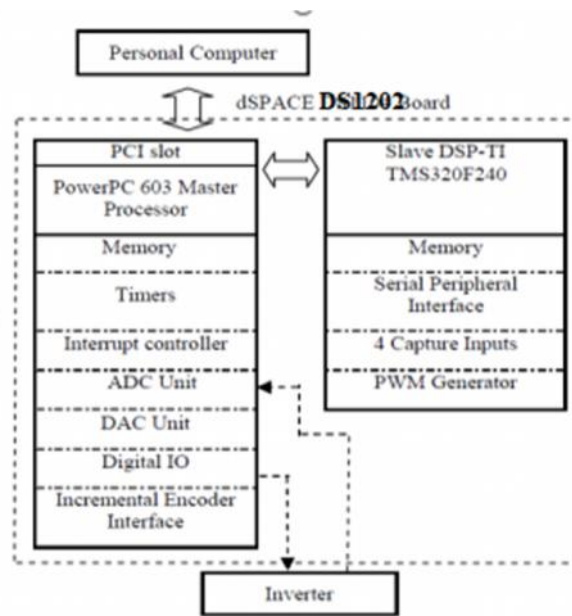

Fig. 4: CONTROLLER BOARD OF DS1202.

The complex control algorithm as elaborated in the previous section is easily implemented in Matlab Simulink by employing the ‘Real-Time Workshop’ (RTW) feature inbuilt in MATLAB/Simulink environment. After creating the model and running the simulation .sdf file is built which actually converts control system algorithm to an equivalent C-code and simultaneously linked to the real inverter hardware. Because of this simplicity and advantages dSPACE DS1202 is very much in use as a development and research tool. To get the output waveforms in real time some special blocks are to be inserted in the simulink model; those are, the dSPACE input-output (I/O) library blocks. These blocks are namely: analog-to digital converter (ADC) units, DS1202ADC, bit input-output (I/O) unit, DS1202BIT_OUT, and 3-phase PWM generation unit, DS1202SL_DSP_PWM3. DS1202

and also its other variants are used mainly for building of prototypes as a research tool for developing real complex control algorithms. Also with increasing number of switching devices a very effective and error free control strategy can only be built in a system like dSPACE for its special feature of software and hardware linkage.



Fig.5: Dspace MicroLabBox Toolkit.

2.3 MATLAB :

MATLAB is a high-performance language for technical computing. It integrates computation, visualization, and programming in an easy-to-use environment where problems and solutions are expressed in familiar mathematical notation.

Typical uses include:

-) Math and computation
-) Algorithm development
-) Modeling, simulation, and prototyping
-) Data analysis, exploration, and visualization
-) Scientific and engineering graphics

Features of Matlab:-

- J · *Simulink*: Simulink® is a block diagram environment for multidomain simulation and Model-Based Design. It supports simulation, automatic code generation, and continuous test and verification of embedded systems.
- J · *Language Fundamentals*: Syntax, operators, data types, array indexing and manipulation
- J · *Mathematics*: Linear algebra, differentiation and integrals, Fourier transforms, and other mathematics
- J · *Graphics*: Two- and three-dimensional plots, images, animation, visualization
- J · *Data Import and Analysis*: Import and export, preprocessing, visual exploration
- J · *Programming Scripts and Functions*: Program files, control flow, editing, debugging
- J · *App Building*: App development using App Designer, GUIDE, or a programmatic workflow
- J · *Advanced Software Development*: Object-oriented programming; code performance; unit testing; external interfaces to Java®, C/C++, .NET and other languages
- J · *Desktop Environment*: Preferences and settings, platform differences
- J · *Supported Hardware*: Support for third-party hardware, such as webcam, Arduino®, and Raspberry Pi™ hardware. Also the MicroLab box can be used to get the real time output from the Simulink files

About Simulink:

- J Simulink® is a block diagram environment for multidomain simulation and Model-Based Design.
- J Simulink provides a graphical editor, customizable block libraries, and solvers for modeling and simulating dynamic systems. It is integrated with MATLAB®, enabling us to incorporate MATLAB algorithms into models and export simulation results to MATLAB for further analysis.
- J In this project, our Hardware and Software part both are based on Simulink. In the software part the whole thing is simulated in Simulink and in the hardware part the

control signal is also generated using the Simulink file by getting a real time output using *MicroLab Box and dSPACE* software.

3. SOFTWARE IMPLEMENTATION :

3.1 Zero Crossing Detector Circuit :

When signal changes from positive to negative point i.e. crossing axis value become zero this is known as zero cross detection.

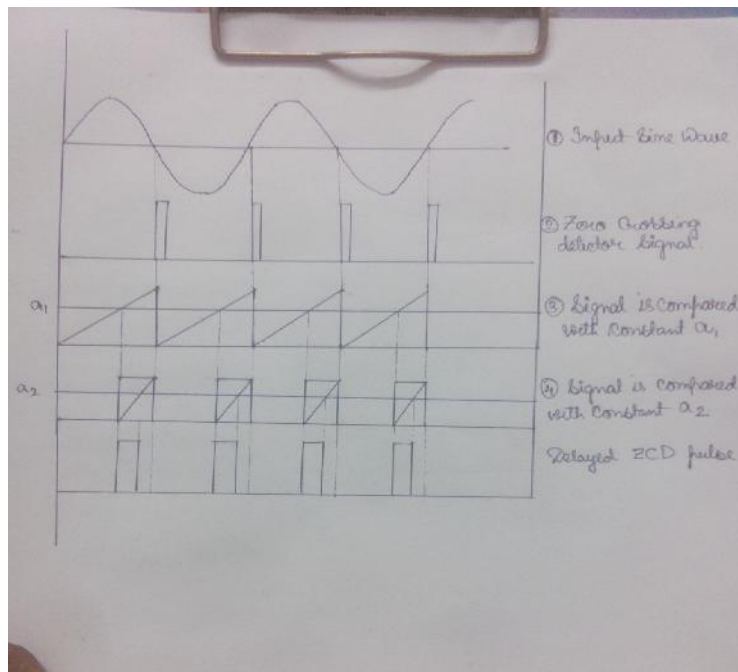

Fig.6: Waveform of ZCD and delayed output

An input signal is applied as shown in fig. 1, we integrate the input signal for every half cycle shown in fig. 2. After that we take a constant α_1 firing angle parallel to x-axis. So, when the slope of input signal is greater than the constant firing angle then a pulse is generated as shown in fig. 3. Now again we integrate the firing pulse of fig. 3 and a constant angle α_2 is fired which is parallel to x-axis. In this fig.3, if the slope of the pulse is smaller than the firing angle then the resultant pulse is obtained which is shown in fig. 4.

ZCD and delayed output waveform using MATLAB :

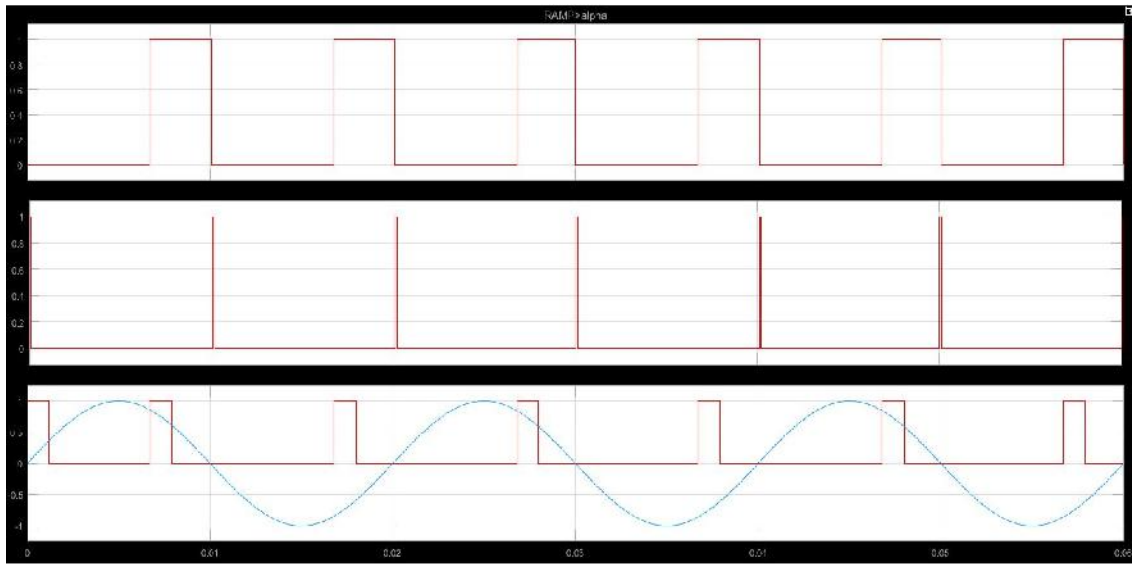

Fig.7: ZCD and delayed output waveform using MATLAB .

MAIN SIMULATION CIRCUIT :

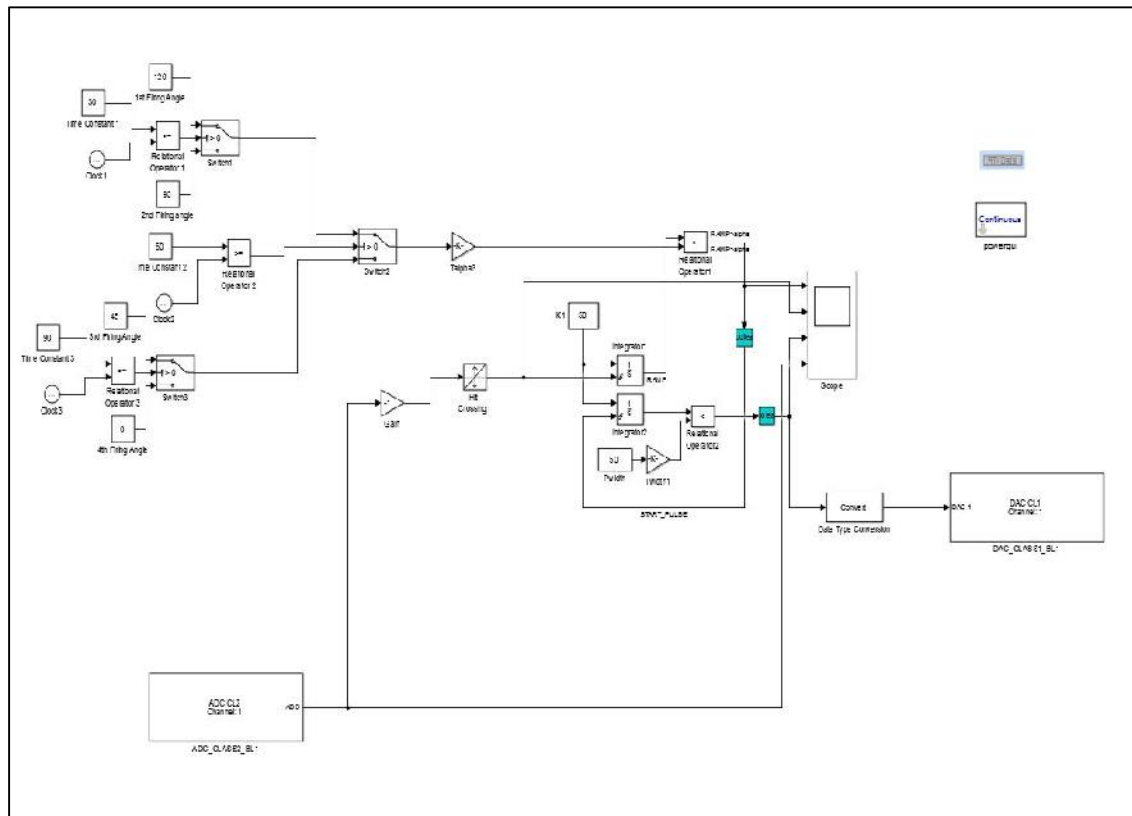

Fig.8: Simulink Circuit Diagram (ZCD along with triggering circuit)

Initially, the Simulink model starts running at 120° as firing angle of Switch1. The function of the relation operator is to control the toggle between normally close and normally open terminal of the switch. When the time constant is greater than equal to 30° , then the normally closed terminal gets open and normally open terminal get closed. In this way 120° firing angle of Switch1 is changed to 90° firing angle.

Switch2 is the main toggling switch. When the time constant is greater than equal to 60° , then the normally closed terminal gets open and normally open terminal get closed. In this way Switch1 and Switch3 can be toggled as per need.

When the time constant is greater than equal to 60° , 90° firing angle of Switch1 is changed 45° firing angle of Switch3. When the time constant is greater than equal to 90° , then the normally closed terminal gets open and normally open terminal get closed. In this way 45° firing angle of Switch3 is changed to 0° firing angle.

dSpace Control Desk:

dSpace control desk is a universal modular experiment and instrumentation software for electronic control unit development. It perform all necessary tasks and gives a single working environment, from the start of the experimentation right to the end.



Fig.13: dSpace Control Desk

4. HARDWARE IMPLEMENTATION

4.1 BLOCK DIAGRAM

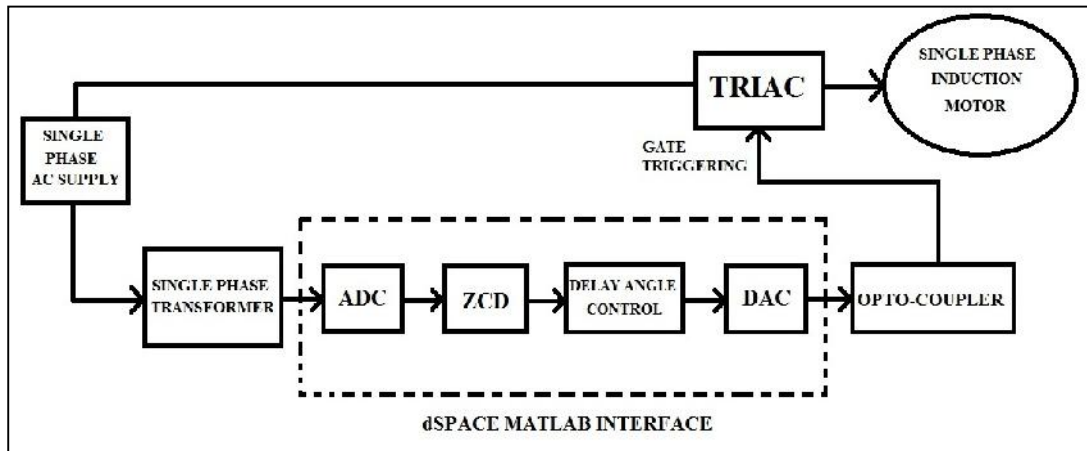

Fig.14: Block Diagram of Soft starter of an Induction Motor

4.2 CIRCUIT DIAGRAM

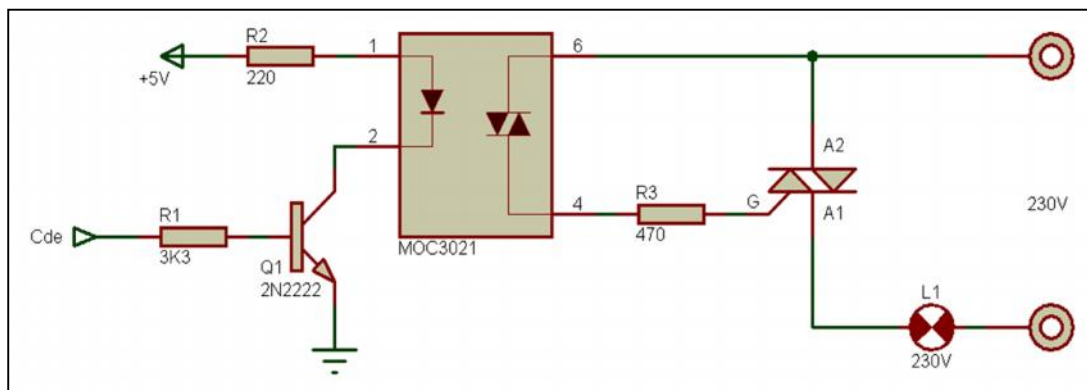

Fig.15: Circuit Diagram of Soft starter of an Induction Motor

4.3 CIRCUIT DESCRIPTION

When a 5V input pulse is applied to the resistance R1 and R2 respectively. The pulse from resistance R2 is flowing from Pin1 to Pin2 and the pulse from resistance R1 is flowing from

transistor Q1 to the ground. So, the LED of MOC3021 is indicated high when the current is flown from it.

Thus the light produced by this LED activates the diac of MOC3021 to make it conductive and that time power is switched ON. Now, when we supply 230V to the power circuit, the current flows from Pin6 to Pin4 and the gate terminal of the TRIAC of power circuit is triggerred. And the lamp gives the output of the circuit. That is how the soft starter circuitry works.

4.4 HARDWARE MODEL :

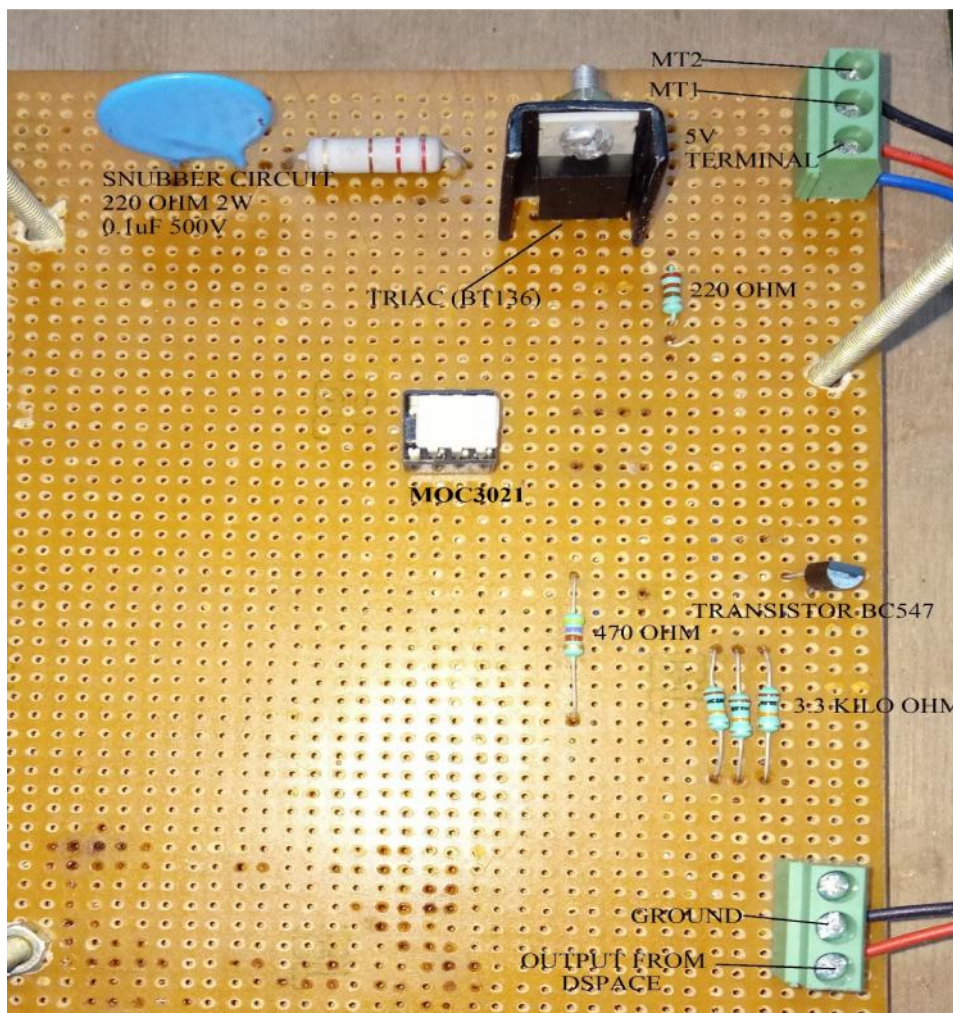

Fig:16 : LIST OF HARDWARE COMPONENT

-) Veroboard
-) Opto-Coupler MOC3021
-) Triac BT-136
-) Transistor BC-547
-) Resistors: 0.2k, 0.3k, 10k, 100k
-) 6V, 500mA Transformer
-) Two Pin Plug
-) IC Base
-) 0.1uF 500V Capacitor

4.6 FULL HARDWARE MODEL :

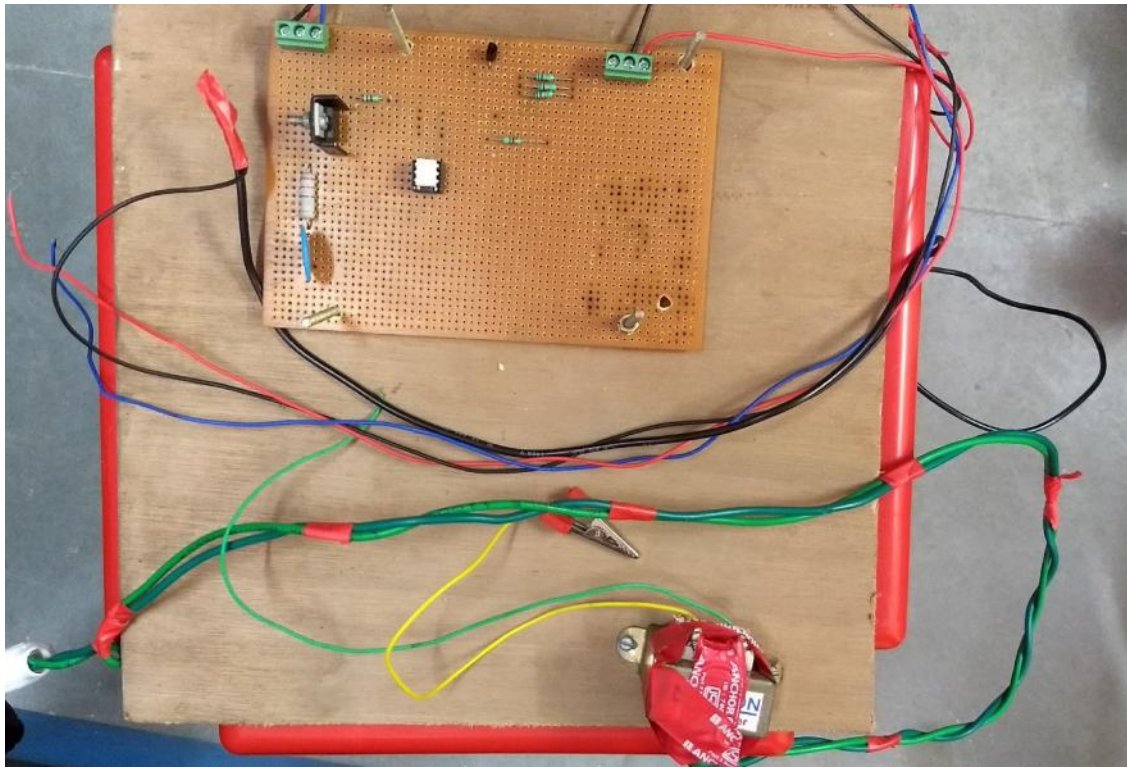

Fig.17: Full hardware circuit board along with 6v transformer

Full Setup of Final Testing (Fig. 18):



This photos contains the final setup of testing our hardware. Using Dspace input signal, we are trying to start the induction moton with different firing angles. Alongside, we serially connect a 40W bulb to get better result of changing in firing angle.

Real time Simulation :

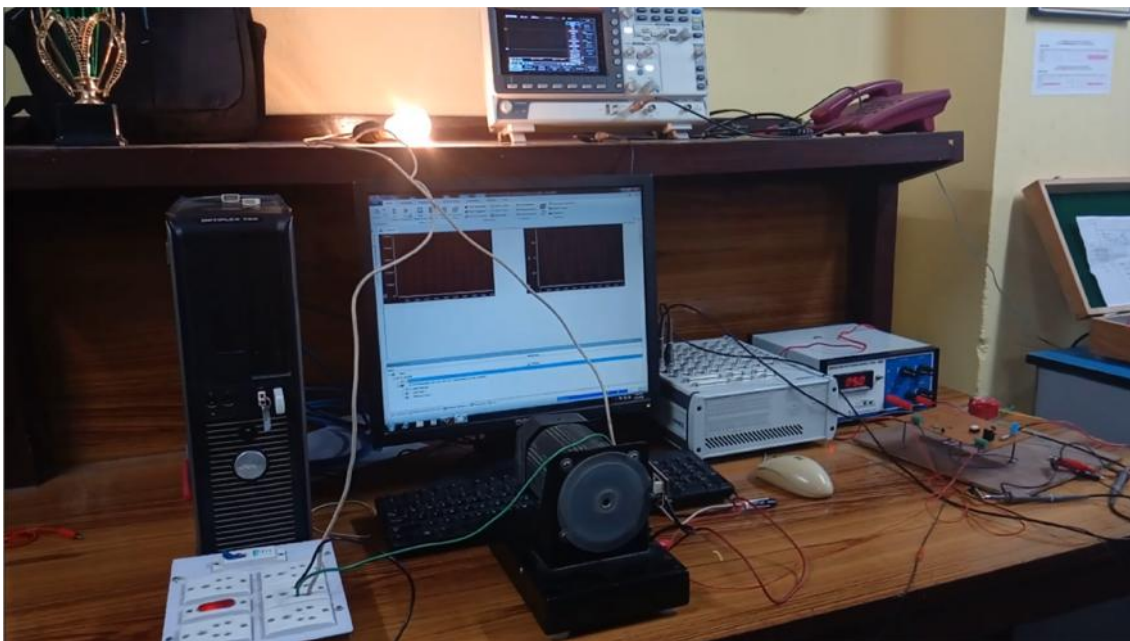

Fig.19: Real time Simulation

4.6 MAIN HARDWARE COMPONENTS USED:

I. Opto-Coupler MOC3021:

MOC3021 is an opto-coupler designed for triggering TRIACS. By using this we can trigger anywhere in the cycle, so can call them as non-zero opto-coupler. MOC3021 are very widely used and can be quite easily obtained from many sources. It comes in 6-pin DIP shown in figure.

Features:

1. 400V Photo- triac driver output
2. Gallium-Arsenic-Diode Infrared Source and Optically-Coupled Silicon triac driver
3. High isolation 7500V Peak
4. Output Driver Designed for 220Vac
5. Standard 6-terminal plastic DIP

II. TRIAC BT-136:

Triac is a bidirectional semiconductor device with three terminals which is used for bidirectional current both in positive as well as in negative cycle.

Triac can be triggered by both positive and negative current applied to its gate. There are many different types of triac. The type of triac that is used in this project is BT136. Reason for choosing this triac is that it is used in motor control application with high voltage and current rating which is suitable with induction motor as compared to other the triacs. It is easy available and inexpensive.

III. TRANSISTOR BC547:

BC547 is a NPN transistor hence the collector and emitter will be left open (Reverse biased) when the base pin is held at ground and will be closed (Forward biased) when a signal is provided to base pin. BC547 has a gain value of 110 to 800, this value determines the amplification capacity of the transistor. The maximum amount of current that could flow through the Collector pin is 100mA, hence we cannot connect

loads that consume more than 100mA using this transistor. To bias a transistor we have to supply current to base pin, this current (I_B) should be limited to 5mA.

IV. TRANSFORMER:

Electrical power transformer is a static device which transform electrical energy from one circuit to another without any direct electrical connection and with the help of mutual induction between two windings. It transforms power from one circuit to another circuit without changing its frequency but may be in different voltage level.

Working Principle of Transformer :

The **working principle of transformer** is very simple. It depends upon Faraday's law of electromagnetic induction. Mutual induction between two or more winding is responsible for transformation action in an electrical transformer.

OBSERVATION AND RESULTS :

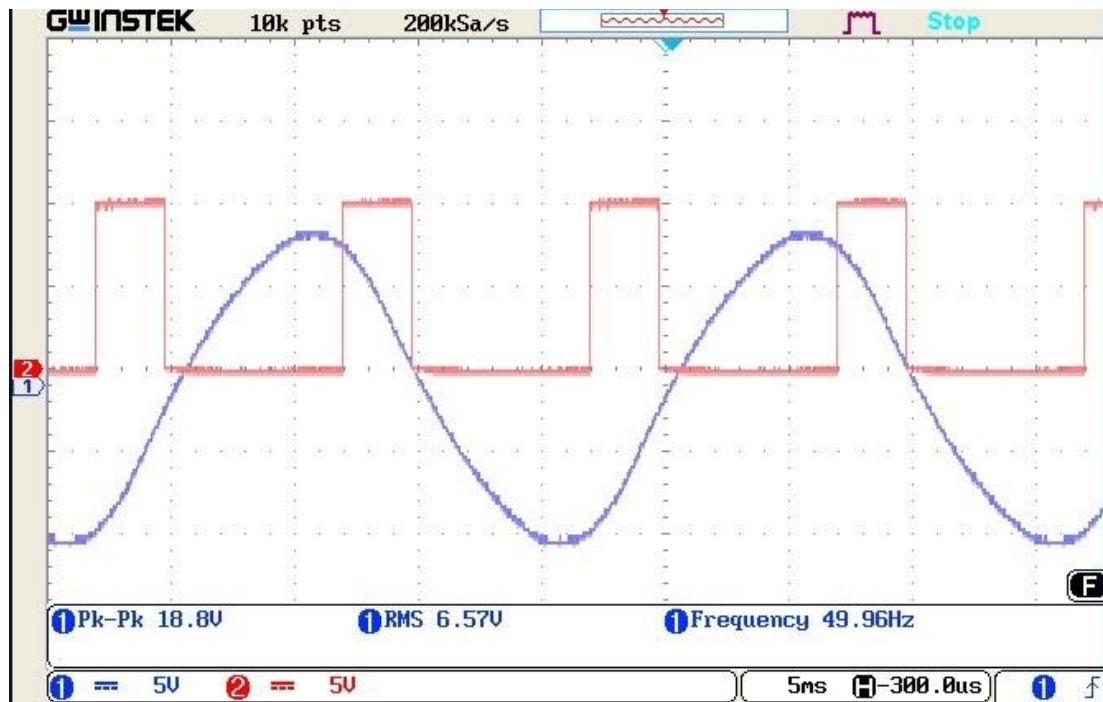

Fig.9: 120° firing angle

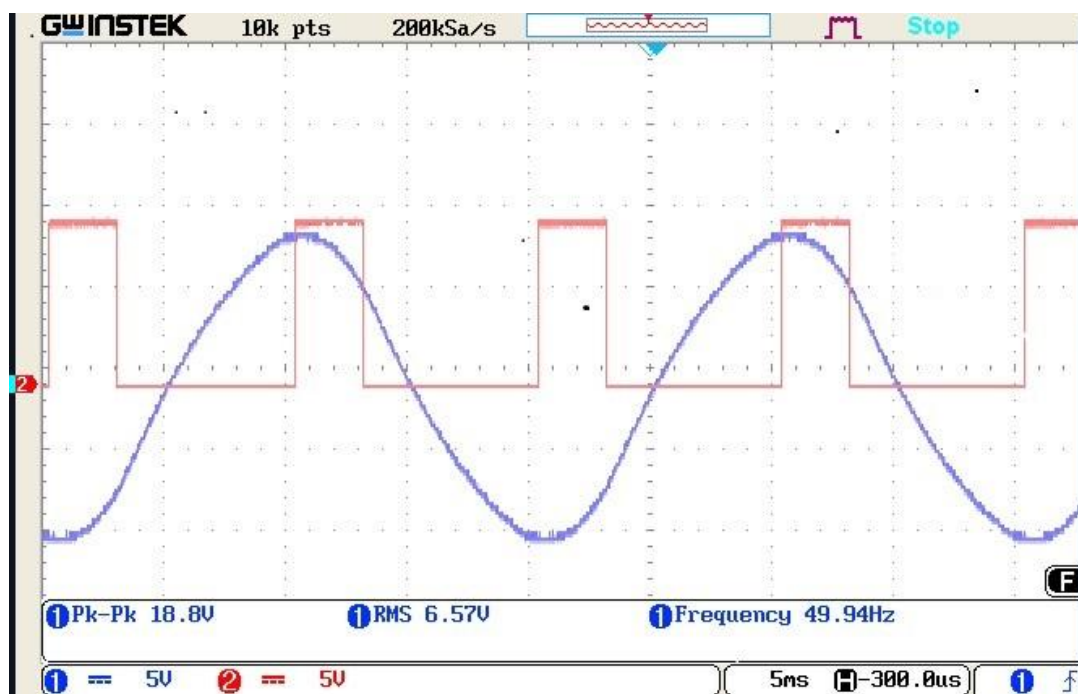

Fig.10: 90° firing angle

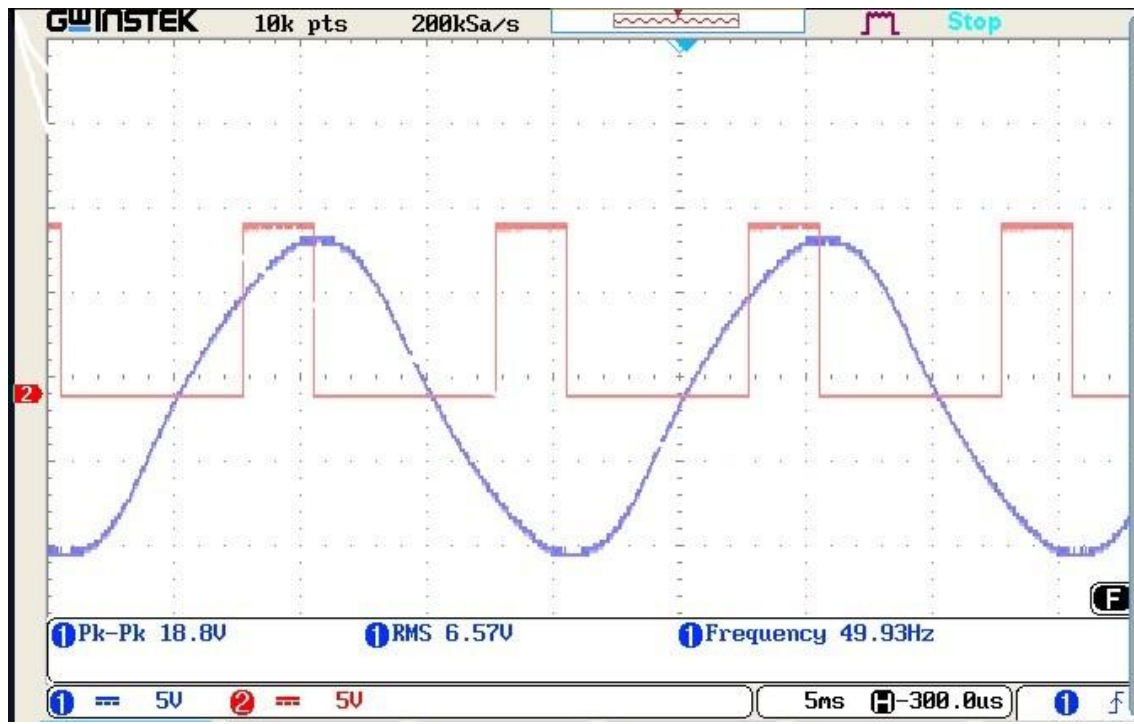

Fig.11: 45° firing angle

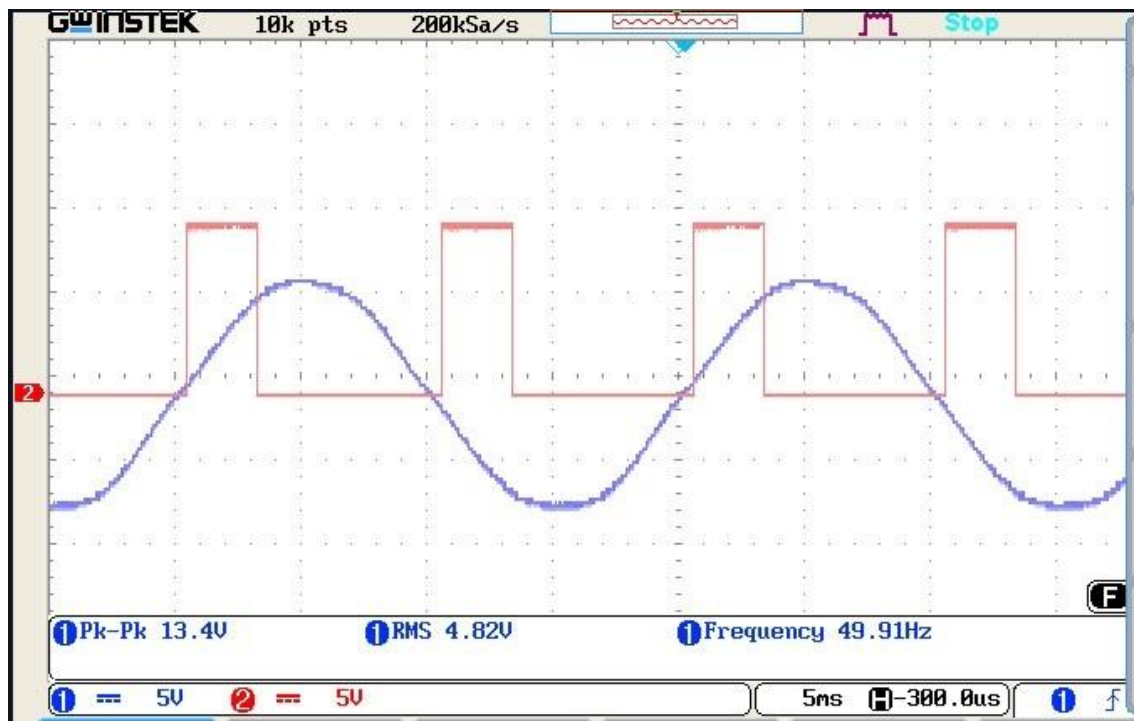

Fig.12: 0° firing angle

Conclusion :

The main objective of the project is to reduce the terminal voltage of the induction motor , so that the motor could start smoothly from rest and thereby increasing the terminal voltage across the motor in steps, as the motor gains speed. In this way, the starting current of the motor which is 4-6 times of the full load current. The motor is protected from any electrical disturbances which can damage the motor. We have successfully build a soft starter by using a triac and an optocoupler, which can initially reduce the terminal voltage across the motor during starting and gradually increase the voltage once the motor starts.

Therefore our main objective of this project is successful.

Future Aspect of the project :

Every project work have their own limitations. Similarly, the main limitation of the project is that we can not vary the speed of the motor as per need as there are certain limit of triggering pulses.

The future aspect of this project is to measure the speed of a induction motor using encoder. Encoder changes the measured speed into an electrical signal so that it can easily fed to a microcontroller. The microcontroller has to be programmed in such a way that it can control the firing pulses and vary the speed of the motor for smoothness and as per need.

APPENDIX A

V. Opto-Coupler MOC3021:

MOC3021 is an opto-coupler designed for triggering TRIACS. By using this we can trigger anywhere in the cycle, so can call them as non-zero opto-coupler. MOC3021 are very widely used and can be quite easily obtained from many sources. It comes in 6-pin DIP shown in figure.

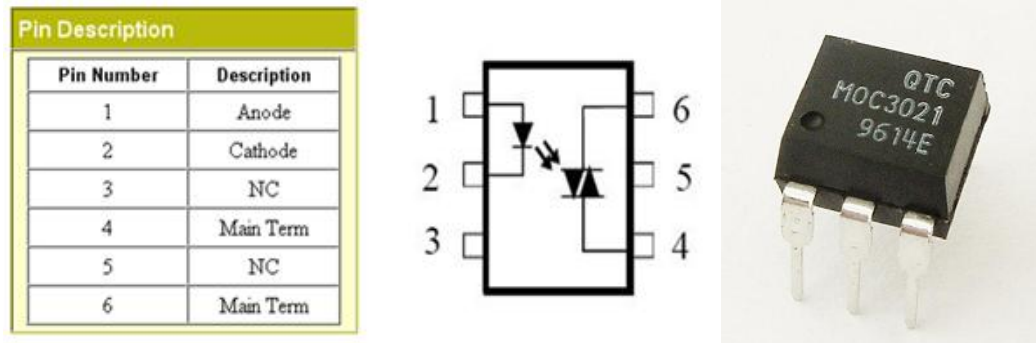

Fig. 20: Pin Description of MOC3021

Features:

6. 400V Photo- triac driver output
7. Gallium-Arsenic-Diode Infrared Source and Optically-Coupled Silicon triac driver
8. High isolation 7500V Peak
9. Output Driver Designed for 220Vac
10. Standard 6-terminal plastic DIP

There are many application of MOC3021 such as solenoid/valve controls, lamp ballasts, interfacing microprocessors to 115/240 Vac peripherals, motor controls and incandescent lamp dimmers.

Application of MOC3021:

From the below circuit, the most commonly used is an opto-coupler MOC3021 with an LED diac type combination. Additionally while using this with microcontroller and one LED can be connected in series with MOC3021, LED to indicate when high is given from micro-controller such that we can know current is flowing internal LED of

the opto-coupler. When logic high is given then the current flows through the LED from pin 1 to 2. So in this process LED light falls on DIAC causing 6 and 4 to close. During each half cycle current flows through gate, series resistor and through opto-diac for the main thyristor/triac to trigger for the load to operate.

VI. TRIAC BT-136:

Triac is a bidirectional semiconductor device with three terminals which is used for bidirectional current both in positive as well as in negative cycle.

Triac can be triggered by both positive and negative current applied to its gate. There are many different types of triac. The type of triac that is used in this project is BT136. Reason for choosing this triac is that it is used in motor control application with high voltage and current rating which is suitable with induction motor as compared to other the triacs. It is easy available and inexpensive.

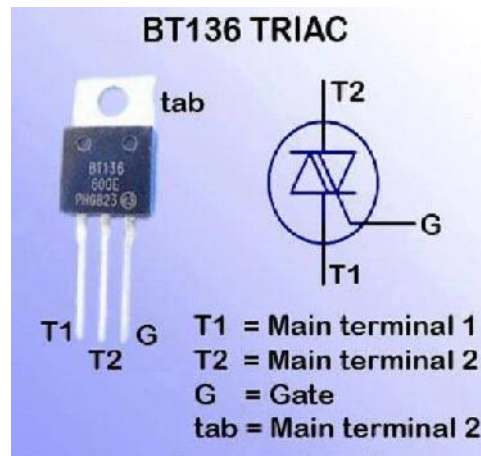

Fig.21 Pin Description of TRIAC BT-136

Features of BT136:

-) Direct triggering from low power drivers and logic Ics.
-) High blocking voltage capability.
-) Low holding current for low current loads and lowest EMI at commutation.
-) Sensitive gate.
-) Triggering in all four quadrants.

Applications of BT136:

-) Universally useful in motor control.
-) General purpose switching.

VII. TRANSISTOR BC547:

BC547 is a NPN transistor hence the collector and emitter will be left open (Reverse biased) when the base pin is held at ground and will be closed (Forward biased) when a signal is provided to base pin. BC547 has a gain value of 110 to 800, this value determines the amplification capacity of the transistor. The maximum amount of current that could flow through the Collector pin is 100mA, hence we cannot connect loads that consume more than 100mA using this transistor. To bias a transistor we have to supply current to base pin, this current (I_B) should be limited to 5mA.

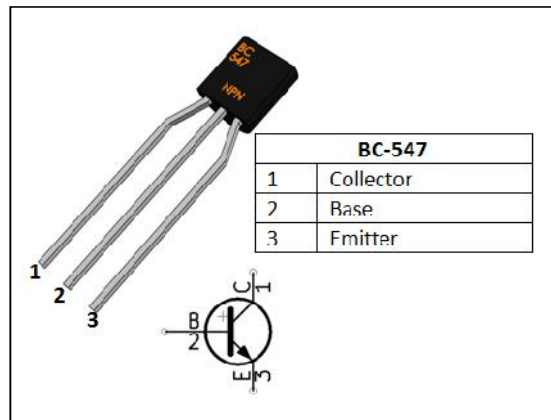

Fig.22 Pin Description of BC-547

BC547 acts as SWITCH

When a transistor is used as a switch it is operated in the **Saturation and Cut-Off Region** as explained above. As discussed a transistor will act as an Open switch during Forward Bias and as a Closed switch during Reverse Bias, this biasing can be achieved by supplying the required amount of current to the base pin. As mentioned the biasing current should maximum of 5mA. Anything more than 5mA will kill the

Transistor; hence a resistor is always added in series with base pin. The value of this resistor (R_B) can be calculated using below formulae.

$$R_B = \frac{V_B}{I_B}$$

Where, $V_B = 5V$ for BC547.

$I_B =$ does not exceed mA.

VIII. TRANSFORMER:

Electrical power transformer is a static device which transform electrical energy from one circuit to another without any direct electrical connection and with the help of mutual induction between two windings. It transforms power from one circuit to another circuit without changing its frequency but may be in different voltage level.

Working Principle of Transformer :

The **working principle of transformer** is very simple. It depends upon Faraday's law of electromagnetic induction. Mutual induction between two or more winding is responsible for transformation action in an electrical transformer.

Basic Theory of Transformer :

We have one winding which is supplied by an alternating electrical source. The alternating current through the winding produces a continually changing flux or alternating flux that surrounds the winding. If any other winding is brought nearer to the previous one, obviously some portion of this flux will link with the second. As this flux is continually changing in its amplitude and direction, there must be a change in flux linkage in the second winding or coil. According to Faraday's law of electromagnetic induction, there must be an EMF induced in the second. If the circuit of the later winding is closed, there must be a current flowing through it. This is the simplest form of an electrical power transformer, and this is the most basic of **working principle of transformer**.

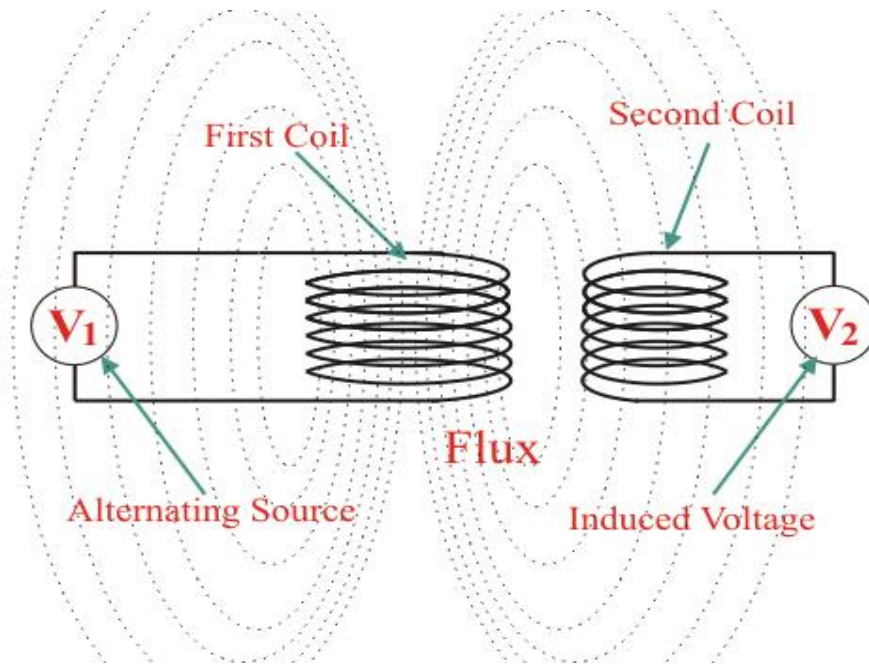
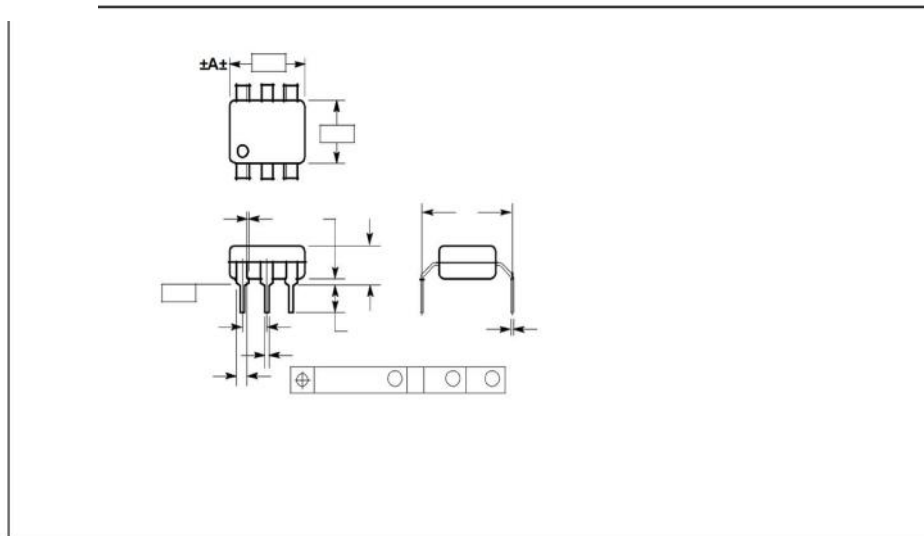

Fig. 23: Working of Transformer



BC547
BC547A
BC547B
BC547C



NPN General Purpose Amplifier

This device is designed for use as general purpose amplifiers and switches requiring collector currents to 300 mA. Sourced from Process 10. See PN100A for characteristics.

Absolute Maximum Ratings* TA = 25°C unless otherwise noted

Symbol	Parameter	Value	Units
V _{CEO}	Collector-Emitter Voltage	45	V
V _{CES}	Collector-Base Voltage	50	V
V _{EB0}	Emitter-Base Voltage	6.0	V
I _C	Collector Current - Continuous	500	mA
T _J , T _{stg}	Operating and Storage Junction Temperature Range	-55 to +150	°C

*These ratings are limiting values above which the serviceability of any semiconductor device may be impaired.

NOTES:

- 1) These ratings are based on a maximum junction temperature of 150 degrees C.
- 2) These are steady state limits. The factory should be consulted on applications involving pulsed or low duty cycle operations.

Thermal Characteristics TA = 25°C unless otherwise noted

Symbol	Characteristic	Max	Units
		BC547 / A / B / C	
P _D	Total Device Dissipation Derate above 25°C	625	mW
		5.0	mW/°C
R _{θJC}	Thermal Resistance, Junction to Case	83.3	°C/W
R _{θJA}	Thermal Resistance, Junction to Ambient	200	°C/W

NPN General Purpose Amplifier

(continued)

Electrical Characteristics

TA = 25°C unless otherwise noted

Symbol	Parameter	Test Conditions	Min	Max	Units
--------	-----------	-----------------	-----	-----	-------

OFF CHARACTERISTICS

$V_{(BR)CEO}$	Collector-Emitter Breakdown Voltage	$I_C = 1.0 \text{ mA}, I_B = 0$	45		V
$V_{(BR)CBO}$	Collector-Base Breakdown Voltage	$I_C = 10 \text{ } \mu\text{A}, I_E = 0$	50		V
$V_{(BR)CES}$	Collector-Base Breakdown Voltage	$I_C = 10 \text{ } \mu\text{A}, I_E = 0$	50		V
$V_{(BR)EBO}$	Emitter-Base Breakdown Voltage	$I_E = 10 \text{ } \mu\text{A}, I_C = 0$	6.0		V
I_{CBO}	Collector Cutoff Current	$V_{CB} = 30 \text{ V}, I_E = 0$ $V_{CB} = 30 \text{ V}, I_E = 0, T_A = +150 \text{ } ^\circ\text{C}$		15 5.0	nA μA

ON CHARACTERISTICS

h_{FE}	DC Current Gain	$V_{CE} = 5.0 \text{ V}, I_C = 2.0 \text{ mA}$	547 547A 547B 547C	110 110 200 420	800 220 450 800	
$V_{CE(sat)}$	Collector-Emitter Saturation Voltage	$I_C = 10 \text{ mA}, I_B = 0.5 \text{ mA}$ $I_C = 100 \text{ mA}, I_B = 5.0 \text{ mA}$			0.25 0.60	V V
$V_{BE(on)}$	Base-Emitter On Voltage	$V_{CE} = 5.0 \text{ V}, I_C = 2.0 \text{ mA}$ $V_{CE} = 5.0 \text{ V}, I_C = 10 \text{ mA}$		0.58	0.70 0.77	V V

SMALL SIGNAL CHARACTERISTICS

h_{re}	Small-Signal Current Gain	$I_C = 2.0 \text{ mA}, V_{CE} = 5.0 \text{ V},$ $f = 1.0 \text{ kHz}$	125	900	
NF	Noise Figure	$V_{CE} = 5.0 \text{ V}, I_C = 200 \text{ } \mu\text{A},$ $R_S = 2.0 \text{ k}\Omega, f = 1.0 \text{ kHz},$ $BW = 200 \text{ Hz}$		10	dB

Triacs logic level

BT136 series D

GENERAL DESCRIPTION

Passivated, sensitive gate triacs in a plastic envelope, intended for use in general purpose bidirectional switching and phase control applications. These devices are intended to be interfaced directly to microcontrollers, logic integrated circuits and other low power gate trigger circuits.

QUICK REFERENCE DATA

SYMBOL	PARAMETER	MAX.	UNIT
V_{DRM}	Repetitive peak off-state voltages	600D 600	V
$I_{T(RMS)}$	RMS on-state current	4	A
I_{TSM}	Non-repetitive peak on-state current	25	A

PINNING - TO220AB

PIN	DESCRIPTION
1	main terminal 1
2	main terminal 2
3	gate
tab	main terminal 2

PIN CONFIGURATION

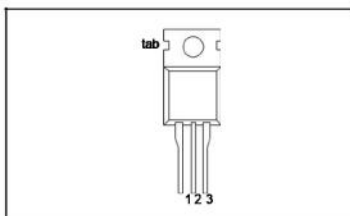

SYMBOL

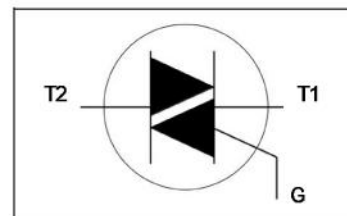

LIMITING VALUES

Limiting values in accordance with the Absolute Maximum System (IEC 134).

SYMBOL	PARAMETER	CONDITIONS	MIN.	MAX.	UNIT
V_{DRM}	Repetitive peak off-state voltages		-	-600D 600	V
$I_{T(RMS)}$	RMS on-state current	full sine wave; $T_{mb} \delta 107^\circ\text{C}$	-	4	A
I_{TSM}	Non-repetitive peak on-state current	full sine wave; $T_j = 25^\circ\text{C}$ prior to surge $t = 20\text{ ms}$	-	25	A
		$t = 16.7\text{ ms}$	-	27	A
I^2t	I^2t for fusing	$t = 10\text{ ms}$	-	3.1	A ² s
dI/dt	Repetitive rate of rise of on-state current after triggering	$I_{TM} = 6\text{ A}$; $I_G = 0.2\text{ A}$; $dI_G/dt = 0.2\text{ A}/\mu\text{s}$			
		T2+ G+	-	50	A/ μs
		T2+ G-	-	50	A/ μs
		T2- G-	-	50	A/ μs
		T2- G+	-	10	A/ μs
I_{GM}	Peak gate current		-	2	A
V_{GM}	Peak gate voltage		-	5	V
P_{GM}	Peak gate power		-	5	W
$P_{GM(AV)}$	Average gate power	over any 20 ms period	-	0.5	W
T_{stg}	Storage temperature		-40	150	$^\circ\text{C}$
T_j	Operating junction temperature		-	125	$^\circ\text{C}$

THERMAL RESISTANCES

SYMBOL	PARAMETER	CONDITIONS	MIN.	TYP.	MAX.	UNIT
$R_{th j-mb}$	Thermal resistance junction to mounting base	full cycle	-	-	3.0	K/W
		half cycle	-	-	3.7	K/W
$R_{th j-a}$	Thermal resistance junction to ambient	in free air	-	60	-	K/W

Triacs
logic level

BT136 series D

STATIC CHARACTERISTICST_j = 25 °C unless otherwise stated

SYMBOL	PARAMETER	CONDITIONS	MIN.	TYP.	MAX.	UNIT	
I _{GT}	Gate trigger current	V _D = 12 V; I _T = 0.1 A	T2+ G+	-	2.0	5	mA
			T2+ G-	-	2.5	5	mA
			T2- G-	-	2.5	5	mA
			T2- G+	-	5.0	10	mA
I _L	Latching current	V _D = 12 V; I _{GT} = 0.1 A	T2+ G+	-	1.6	10	mA
			T2+ G-	-	4.5	15	mA
			T2- G-	-	1.2	10	mA
			T2- G+	-	2.2	15	mA
I _H	Holding current	V _D = 12 V; I _{GT} = 0.1 A	-	1.2	10	mA	
V _T	On-state voltage	I _T = 5 A	-	1.4	1.70	V	
V _{GT}	Gate trigger voltage	V _D = 12 V; I _T = 0.1 A	-	0.7	1.5	V	
I _D	Off-state leakage current	V _D = 400 V; I _T = 0.1 A; T _j = 125 °C	0.25	0.4	-	V	
		V _D = V _{DRM(max)} ; T _j = 125 °C	-	0.1	0.5	mA	

DYNAMIC CHARACTERISTICST_j = 25 °C unless otherwise stated

SYMBOL	PARAMETER	CONDITIONS	MIN.	TYP.	MAX.	UNIT
dV _D /dt	Critical rate of rise of off-state voltage	V _{DM} = 67% V _{DRM(max)} ; T _j = 125 °C; exponential waveform; R _{GK} = 1 k	-	5	-	V/μ s
t _{gt}	Gate controlled turn-on time	I _{TM} = 6 A; V _D = V _{DRM(max)} ; I _G = 0.1 A; dI _G /dt = 5 A/μ s	-	2	-	μ s

Triacs
logic level

BT136 series D

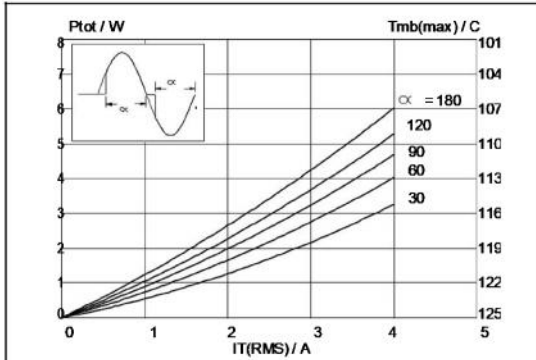

Fig. 1. Maximum on-state dissipation, P_{tot} , versus rms on-state current, $I_{T(RMS)}$, where α = conduction angle.

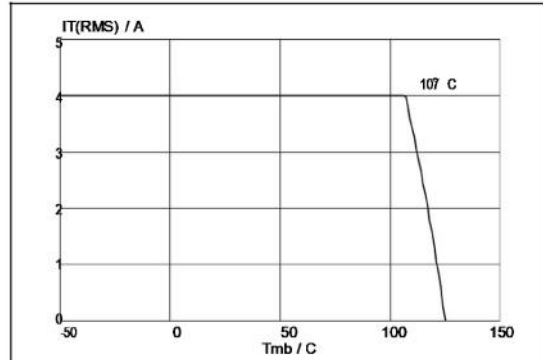

Fig. 4. Maximum permissible rms current $I_{T(RMS)}$, versus mounting base temperature T_{mb} .

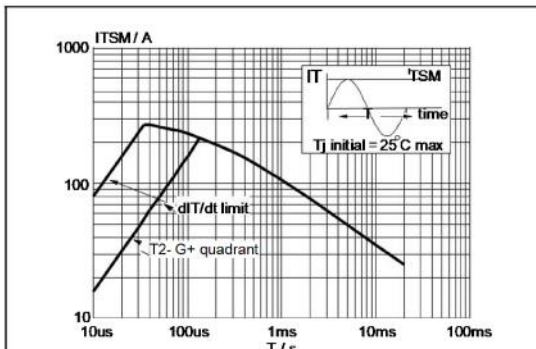

Fig. 2. Maximum permissible non-repetitive peak on-state current I_{TSM} , versus pulse width t_p , for sinusoidal currents, $t_p \leq 20ms$.

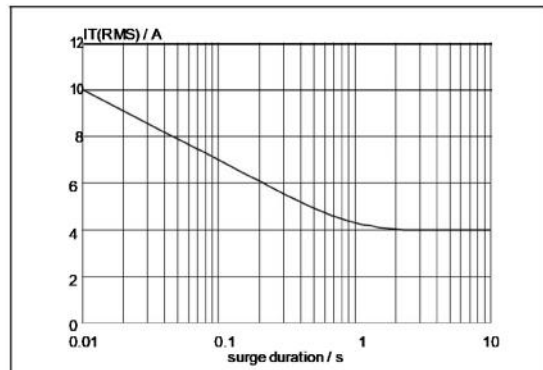

Fig. 5. Maximum permissible repetitive rms on-state current $I_{T(RMS)}$, versus surge duration, for sinusoidal currents, $f = 50$ Hz; $T_{mb} \leq 107^\circ\text{C}$.

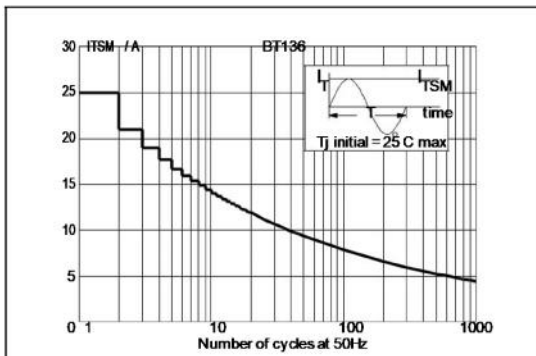

Fig. 3. Maximum permissible non-repetitive peak on-state current I_{TSM} , versus number of cycles, for sinusoidal currents, $f = 50$ Hz.

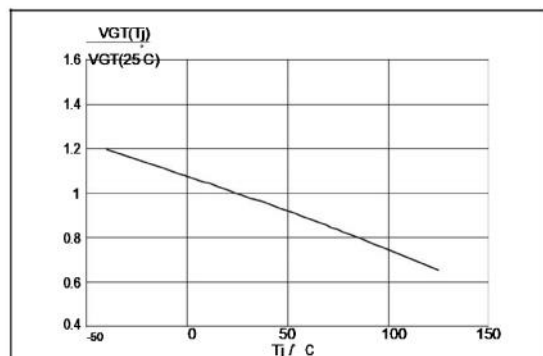

Fig. 6. Normalised gate trigger voltage $V_{GT}(T_j) / V_{GT}(25^\circ\text{C})$, versus junction temperature T_j .

Triacs
logic level

BT136 series D

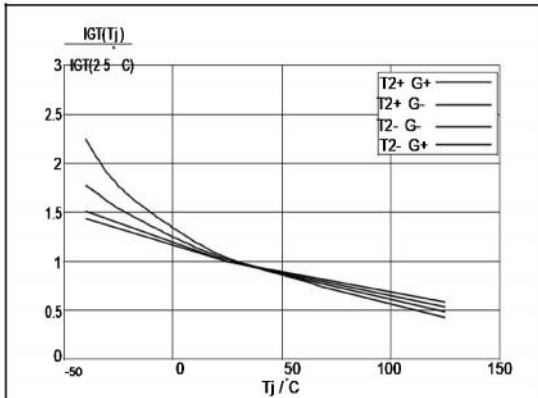

Fig.7. Normalised gate trigger current $I_{GT}(T_j)/I_{GT}(25^\circ\text{C})$, versus junction temperature T_j .

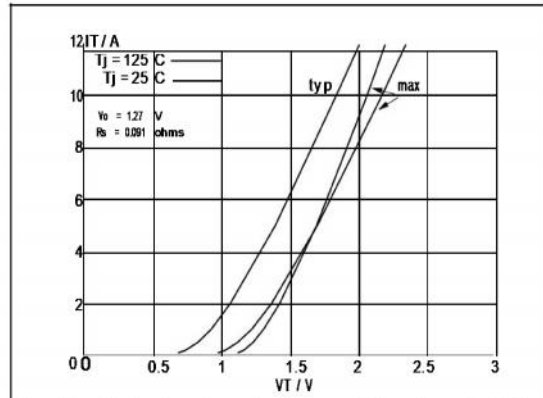

Fig.10. Typical and maximum on-state characteristic.

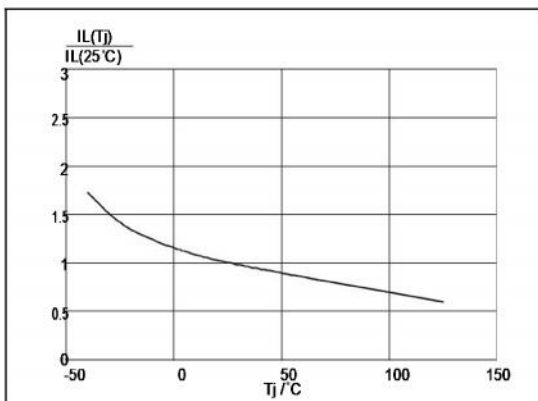

Fig.8. Normalised latching current $I_L(T_j)/I_L(25^\circ\text{C})$, versus junction temperature T_j .

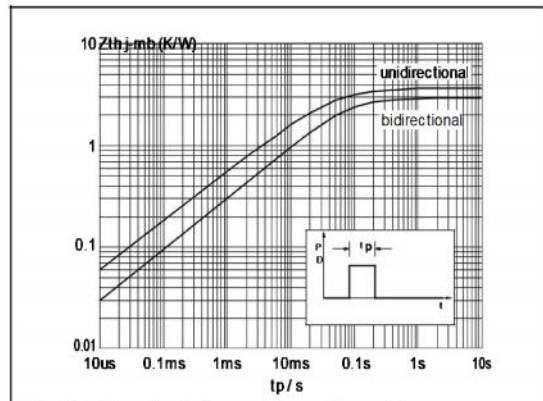

Fig.11. Transient thermal impedance Z_{thj-mb} , versus pulse width t_p .

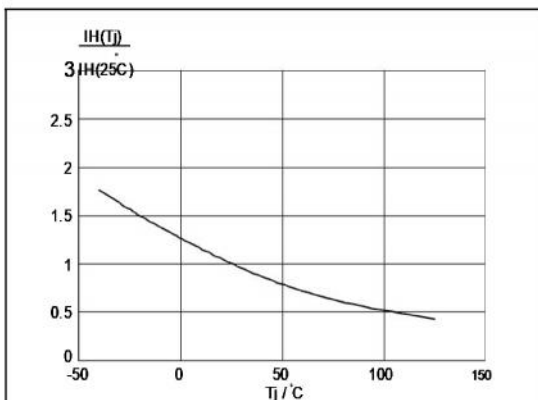

Fig.9. Normalised holding current $I_H(T_j)/I_H(25^\circ\text{C})$, versus junction temperature T_j .

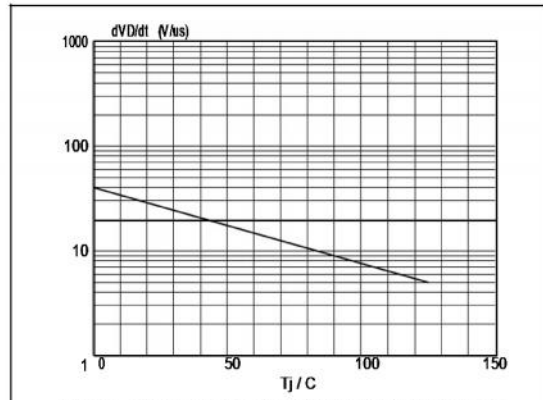

Fig.12. Typical, critical rate of rise of off-state voltage, dV_D/dt versus junction temperature T_j .



6-Pin DIP Random-Phase Optoisolators Triac Driver Output (400 Volts Peak)

The MOC3020 Series consists of gallium arsenide infrared emitting diodes, optically coupled to a silicon bilateral switch.

□ **To order devices that are tested and marked per VDE 0884 requirements, the suffix "V" must be included at end of part number. VDE 0884 is a test option.**

They are designed for applications requiring isolated triac triggering.

Recommended for 115/240 Vac(rms) Applications:

- Solenoid/Valve Controls
- Lamp Ballasts
- Interfacing Microprocessors to 115 Vac Peripherals
- Motor Controls
- Static ac Power Switch
- Solid State Relays
- Incandescent Lamp Dimmers

MAXIMUM RATINGS (TA = 25°C unless otherwise noted)

Rating	Sym bol	Value	Unit
--------	---------	-------	------

INFRARED EMITTING DIODE

Reverse Voltage	VR	3	Volts
Forward Current @ Continuous	IF	60	mA
Total Power Dissipation @ TA = 25°C Negligible Power in Triac Driver	PD	100	mW
Derate above 25°C		1.33	mW/°C

OUTPUT DRIVER

Off-State Output Terminal Voltage	V _{DRM}	400	Volts
Peak Repetitive Surge Current (PW = 1 ms, 120 pps)	I _{TSM}	1	A
Total Power Dissipation @ TA = 25°C Derate above 25°C	PD	300 4	mW mW/°C

TOTAL DEVICE

Isolation Surge Voltage ⁽¹⁾ (Peak ac Voltage, 60 Hz, 1 Second Duration)	V _{ISO}	7500	Vac(pk)
Total Power Dissipation @ TA = 25°C Derate above 25°C	PD	330 4.4	mW mW/°C
Junction Temperature Range	T _J	± 40 to +100	°C
Ambient Operating Temperature Range	T _A	± 40 to +85	°C
Storage Temperature Range	I _{stg}	± 40 to +150	°C
Soldering Temperature (10 s)	I _L	260	°C

1. Isolation surge voltage, V_{ISO}, is an internal device dielectric breakdown rating.
i. For this test, Pins 1 and 2 are common, and Pins 4, 5 and 6 are common.

MOC3021
MOC3022
MOC3023



STANDARD THRU HOLE

SCHEMATIC

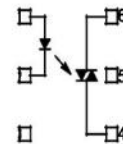

1. ANODE
2. CATHODE
3. NC
4. MAIN TERMINAL
5. SUBSTRATE
6. DO NOT CONNECT
6. MAIN TERMINAL

ELECTRICAL CHARACTERISTICS ($T_A = 25^\circ\text{C}$ unless otherwise noted)

Characteristic	Symbol	Min	Typ	Max	Unit
INPUT LED					
Reverse Leakage Current ($V_R = 3\text{ V}$)	I_R	∅	0.05	100	μA
Forward Voltage ($I_F = 10\text{ mA}$)	V_F	∅	1.15	1.5	Volts
OUTPUT DETECTOR ($I_F = 0$ unless otherwise noted)					
Peak Blocking Current, Either Direction (Rated $V_{DRM}^{(1)}$)	I_{DRM}	∅	10	100	nA
Peak On-State Voltage, Either Direction ($I_{TM} = 100\text{ mA Peak}$)	V_{TM}	∅	1.8	3	Volts
Critical Rate of Rise of Off-State Voltage (Figure 7, Note 2)	dv/dt	∅	10	∅	$\text{V}/\mu\text{s}$
COUPLED					
LED Trigger Current, Current Required to Latch Output (Main Terminal Voltage = $3\text{ V}^{(3)}$)	I_{FT}				mA
	MOC3021	∅	8	15	
	MOC3022	∅	∅	10	
	MOC3023	∅	∅	5	
Holding Current, Either Direction	I_H	∅	100	∅	μA

1. Test voltage must be applied within dv/dt rating.
2. This is static dv/dt . See Figure 7 for test circuit. Commutating dv/dt is a function of the load±driving thyristor(s) only.
3. All devices are guaranteed to trigger at an I_F value less than or equal to max I_{FT} . Therefore, recommended operating I_F lies between max I_{FT} (15 mA for MOC3021, 10 mA for MOC3022, 5 mA for MOC3023) and absolute max I_F (60 mA).

TYPICAL ELECTRICAL CHARACTERISTICS

$T_A = 25^\circ\text{C}$

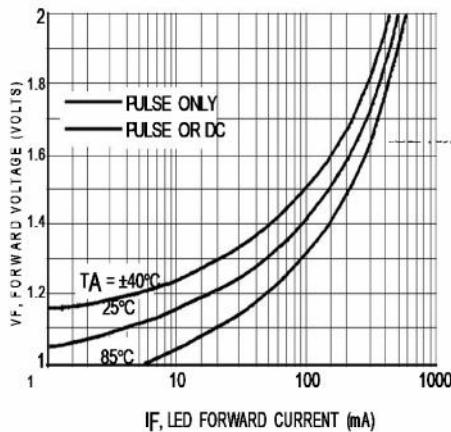

Figure 1. LED Forward Voltage versus Forward Current

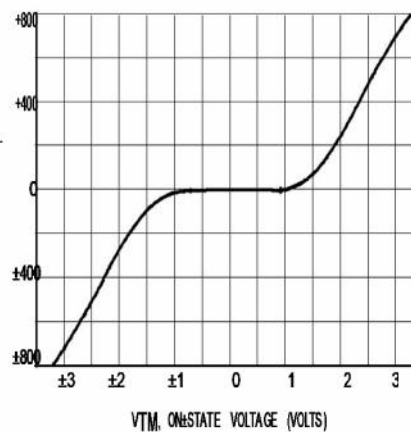

Figure 2. On-State Characteristics

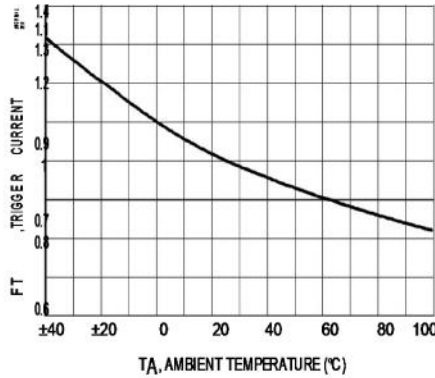

Figure 3. Trigger Current versus Temperature

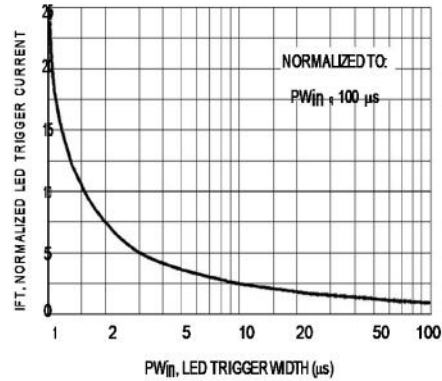

Figure 4. LED Current Required to Trigger versus LED Pulse Width

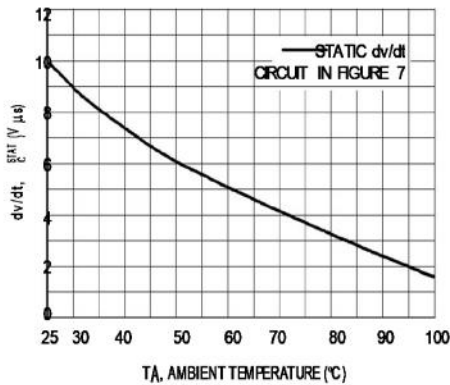

Figure 5. dv/dt versus Temperature

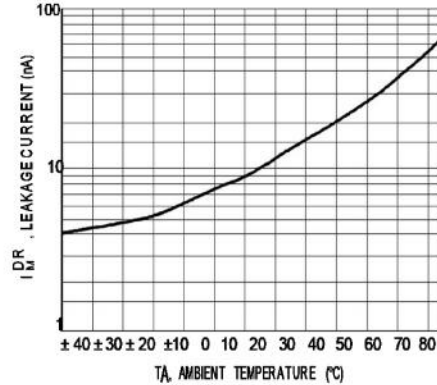

Figure 6. Leakage Current, IDRM versus Temperature

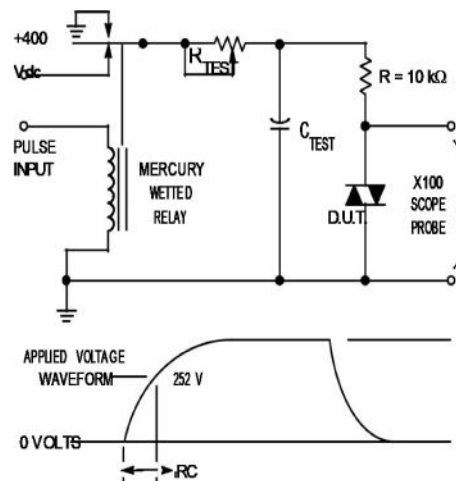
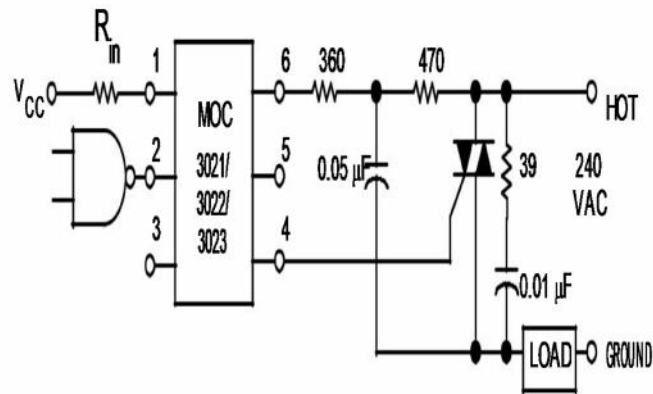

Figure 7. Static dv/dt Test Circuit

1. The mercury wetted relay provides a high speed repeated pulse to the D.U.T.
2. 100x scope probes are used, to allow high speeds and voltages.
3. The worst case condition for static dv/dt is established by triggering the D.U.T. with a normal LED input current, then

removing the current. The variable R_{TEST} allows the dv/dt to be gradually increased until the D.U.T. continues to trigger in response to the applied voltage pulse, even after the LED current has been removed. The dv/dt is then decreased until the D.U.T. stops triggering. RC is measured at this point and recorded.



* This optoisolator should not be used to drive a load directly. It is intended to be a trigger device only.

Additional information on the use of optically coupled triac drivers is available in Application Note AN-780A.

In this circuit the "hot" side of the line is switched and the load connected to the cold or ground side.

The 39 ohm resistor and 0.01 μ F capacitor are for snubbing of the triac, and the 470 ohm resistor and 0.05 μ F capacitor are for snubbing the coupler. These components may or may not be necessary depending upon the particular triac and load used.

Figure 8. Typical Application Circuit

PACKAGE DIMENSIONS

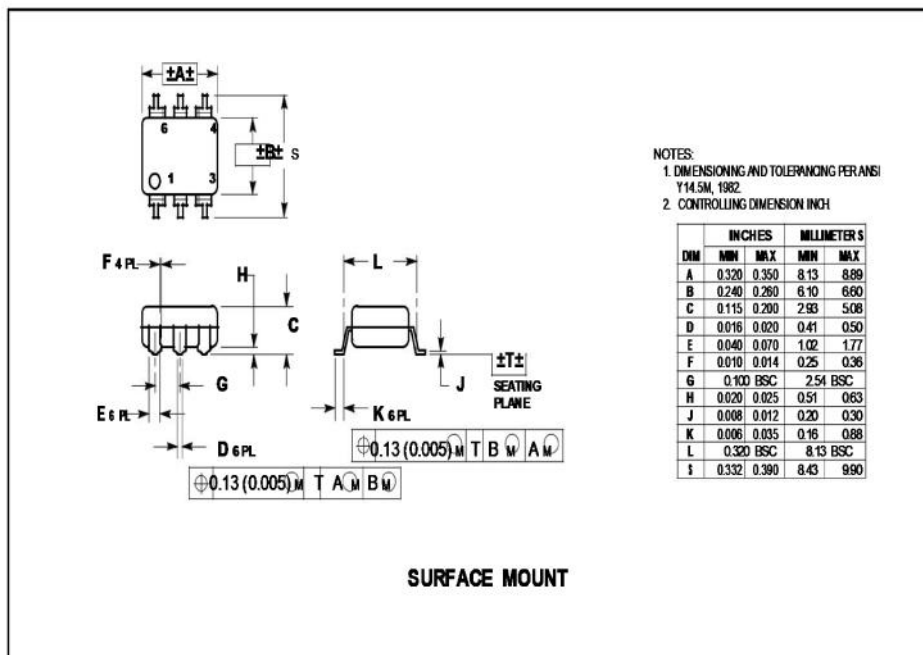
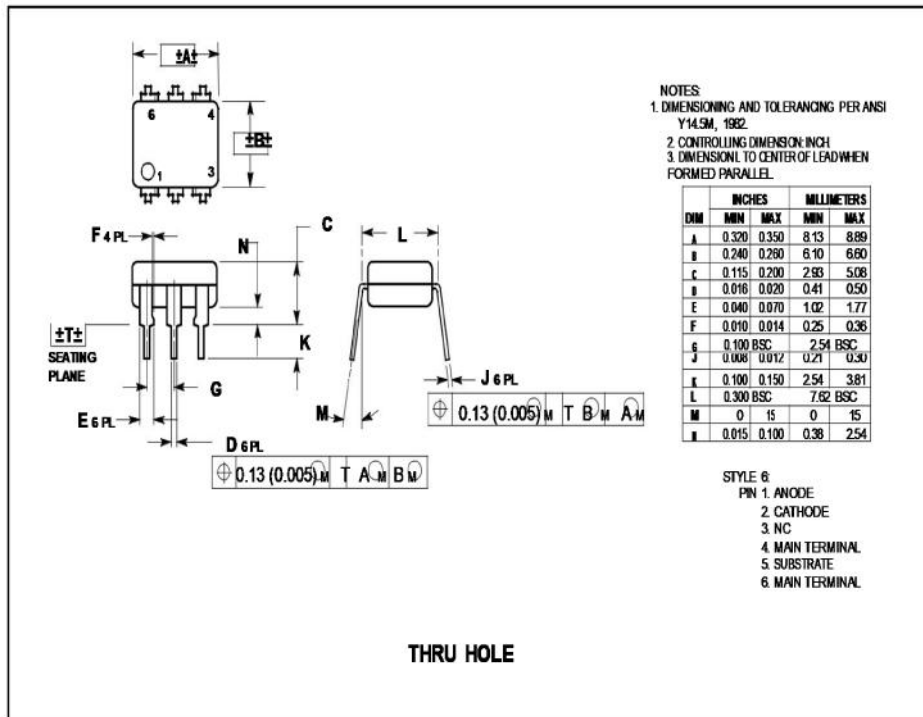

References :

-) Fundamental of Electric Drive by GK Dubey
-) Electrical Machine By Ashfaque Hussain
-) A First course on Electric Drive By Sk Pillai
-) dSpace Microlab toolkit manual
-) Wikipedia
-) Datasheet from farnell.com
-) Dspace.com
-) IEEE module on Soft Starting etc.